

FLUKE®

725

Multifunction Process Calibrator

Product Overview

English
January 2000

© 2000 Fluke Corporation. All rights reserved. Printed in USA
All product names are trademarks of their respective companies.

LIMITED WARRANTY AND LIMITATION OF LIABILITY

Each Fluke product is warranted to be free from defects in material and workmanship under normal use and service. The warranty period is three years and begins on the date of shipment. Parts, product repairs, and services are warranted for 90 days. This warranty extends only to the original buyer or end-user customer of a Fluke authorized reseller, and does not apply to fuses, disposable batteries, or to any product which, in Fluke's opinion, has been misused, altered, neglected, contaminated, or damaged by accident or abnormal conditions of operation or handling. Fluke warrants that software will operate substantially in accordance with its functional specifications for 90 days and that it has been properly recorded on non-defective media. Fluke does not warrant that software will be error free or operate without interruption.

Fluke authorized resellers shall extend this warranty on new and unused products to end-user customers only but have no authority to extend a greater or different warranty on behalf of Fluke. Warranty support is available only if product is purchased through a Fluke authorized sales outlet or Buyer has paid the applicable international price. Fluke reserves the right to invoice Buyer for importation costs of repair/replacement parts when product purchased in one country is submitted for repair in another country.

Fluke's warranty obligation is limited, at Fluke's option, to refund of the purchase price, free of charge repair, or replacement of a defective product which is returned to a Fluke authorized service center within the warranty period.

To obtain warranty service, contact your nearest Fluke authorized service center to obtain return authorization information, then send the product to that service center, with a description of the difficulty, postage and insurance prepaid (FOB Destination). Fluke assumes no risk for damage in transit. Following warranty repair, the product will be returned to Buyer, transportation prepaid (FOB Destination). If Fluke determines that failure was caused by neglect, misuse, contamination, alteration, accident, or abnormal condition of operation or handling, including overvoltage failures caused by use outside the product's specified rating, or normal wear and tear of mechanical components, Fluke will provide an estimate of repair costs and obtain authorization before commencing the work. Following repair, the product will be returned to the Buyer transportation prepaid and the Buyer will be billed for the repair and return transportation charges (FOB Shipping Point).

THIS WARRANTY IS BUYER'S SOLE AND EXCLUSIVE REMEDY AND IS IN LIEU OF ALL OTHER WARRANTIES, EXPRESS OR IMPLIED, INCLUDING BUT NOT LIMITED TO ANY IMPLIED WARRANTY OF MERCHANTABILITY OR FITNESS FOR A PARTICULAR PURPOSE. FLUKE SHALL NOT BE LIABLE FOR ANY SPECIAL, INDIRECT, INCIDENTAL OR CONSEQUENTIAL DAMAGES OR LOSSES, INCLUDING LOSS OF DATA, ARISING FROM ANY CAUSE OR THEORY.

Since some countries or states do not allow limitation of the term of an implied warranty, or exclusion or limitation of incidental or consequential damages, the limitations and exclusions of this warranty may not apply to every buyer. If any provision of this Warranty is held invalid or unenforceable by a court or other decision-maker of competent jurisdiction, such holding will not affect the validity or enforceability of any other provision.

Fluke Corporation
P.O. Box 9090
Everett, WA 98206-9090
U.S.A.

Fluke Europe B.V.
P.O. Box 1186
5602 BD Eindhoven
The Netherlands

Multifunction Process Calibrator

Introduction

Your Fluke 725 Multifunction Process Calibrator (referred to as “the calibrator”) is a handheld, battery-operated instrument that measures and sources electrical and physical parameters.

The calibrator has the following features and functions:

- A split-screen display. The upper display allows you to measure volts, current, and pressure only. The lower display allows you to measure and source volts, current, pressure, resistance temperature detectors, thermocouples, frequency, and ohms.
- Calibrates a transmitter using the split-screen.
- A thermocouple (TC) input/output terminal and internal isothermal block with automatic reference-junction temperature compensation.
- Stores and recalls setups.
- Manual stepping and automatic stepping and ramping.

- Controls the calibrator remotely from a PC running a terminal emulator program.

Accessing the Users Manual

The *725 Users Manual* is available on the 725 CD included with your calibrator.

Contacting Fluke

To order accessories, receive operating assistance, or get the location of the nearest Fluke distributor or Service Center, call:

USA: 1-888-99-FLUKE (1-888-993-5853)

Canada: 1-800-36-FLUKE (1-800-363-5853)

Europe: +31 402-678-200

Japan: +81-3-3434-0181

Singapore: +65-738-5655

Anywhere in the world: +1-425-446-5500

Or, visit Fluke's Web site at www.fluke.com.

Standard Equipment

The items listed below are included with your calibrator. If the calibrator is damaged or something is missing, contact the place of purchase immediately. To order replacement parts or spares, see the user-replaceable parts list in Table 4.

- TL75 test leads (one set)
- AC70A alligator clips (one set)
- Stackable alligator clip test leads (one set)
- *725 Product Overview Manual*
- *725 CD-ROM* (contains Users Manual)

Safety Information

The calibrator is designed in accordance with IEC1010-1, ANSI/ISA S82.01-1994 and CAN/CSA C22.2 No. 1010.1-92. Use the calibrator only as specified in this manual, otherwise the protection provided by the calibrator may be impaired.

A **Warning** identifies conditions and actions that pose hazard(s) to the user; a **Caution** identifies conditions and actions that may damage the calibrator or the equipment under test.

International symbols used on the calibrator and in this manual are explained in Table 1.

Warning

To avoid possible electric shock or personal injury:

- Do not apply more than the rated voltage, as marked on the calibrator, between the terminals, or between any terminal and earth ground (30 V 24 mA max all terminals).
- Before each use, verify the calibrator's operation by measuring a known voltage.
- Follow all equipment safety procedures.
- Never touch the probe to a voltage source when the test leads are plugged into the current terminals.
- Do not use the calibrator if it is damaged. Before you use the calibrator, inspect the case. Look for cracks or missing plastic. Pay particular attention to the insulation surrounding the connectors.
- Select the proper function and range for your measurement.
- Make sure the battery door is closed and latched before you operate the calibrator.
- Remove test leads from the calibrator before you open the battery door.











- Inspect the test leads for damaged insulation or exposed metal. Check test leads continuity. Replace damaged test leads before you use the calibrator.
- When using the probes, keep your fingers away from the probe contacts. Keep your fingers behind the finger guards on the probes.
- Connect the common test lead before you connect the live test lead. When you disconnect test leads, disconnect the live test lead first.
- Do not use the calibrator if it operates abnormally. Protection may be impaired. When in doubt, have the calibrator serviced.
- Do not operate the calibrator around explosive gas, vapor, or dust.
- When using a pressure module, make sure the process pressure line is shut off and depressurized before you connect it or disconnect it from the pressure module.
- Use only 4 AA batteries, properly installed in the calibrator case, to power the calibrator.
- Disconnect test leads before changing to another measure or source function.
- When servicing the calibrator, use only specified replacement parts.
- To avoid false readings, which could lead to possible electric shock or personal injury, replace the battery as soon as the battery indicator () appears.

Caution

To avoid possible damage to calibrator or to equipment under test:

- Disconnect the power and discharge all high-voltage capacitors before testing resistance or continuity.
- Use the proper jacks, function, and range for your measurement or sourcing application.

Table 1. International Symbols

| | | | |
|---|---|---|---|
|  | AC - Alternating current |  | Double insulated |
|  | DC - Direct current |  | Battery |
|  | Earth ground |  | Refer to the manual for information about this feature. |
|  | Pressure |  | ON/OFF |
|  | Conforms to Canadian Standards Association directives |  | Conforms to European Union directives |

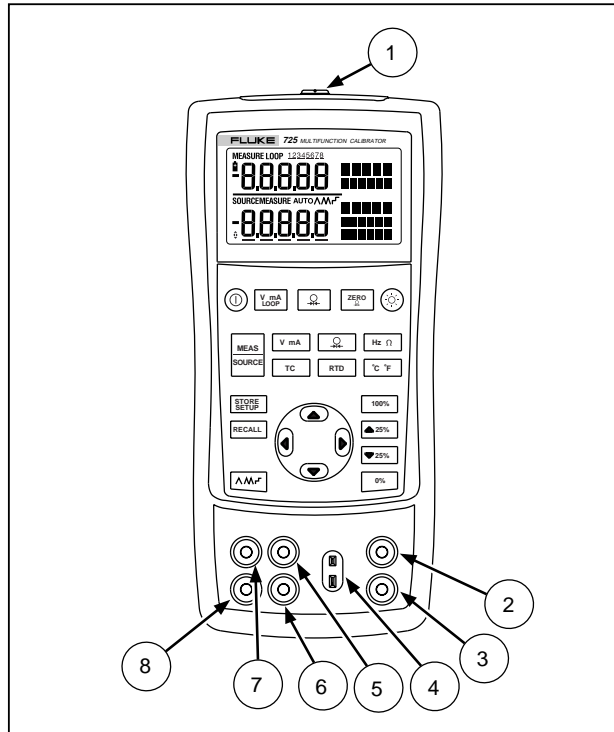

sh05f.eps

Figure 1. Input/Output Terminals and Connectors

Table 2. Input/Output Terminals and Connectors

| No | Name | Description |
|------|---|--|
| ① | Pressure module connector | Connects the calibrator to a pressure module or the calibrator to a PC for a remote control connection. |
| ②, ③ | MEASURE V, mA terminals | Input terminals for measuring voltage, current, and supplying loop power. |
| ④ | TC input/output | Terminal for measuring or simulating thermocouples. This terminal accepts a miniature polarized thermocouple plug with flat, in-line blades spaced 7.9 mm (0.312 in) center to center. |
| ⑤, ⑥ | SOURCE/MEASURE E V, RTD, Hz, Ω terminals | Terminals for sourcing or measuring voltage, resistance, frequency, and RTDs. |
| ⑦, ⑧ | SOURCE/MEASURE E mA terminals, 3W, 4W | Terminals for sourcing and measuring current, and performing 3W and 4W RTD measurements. |

Keys

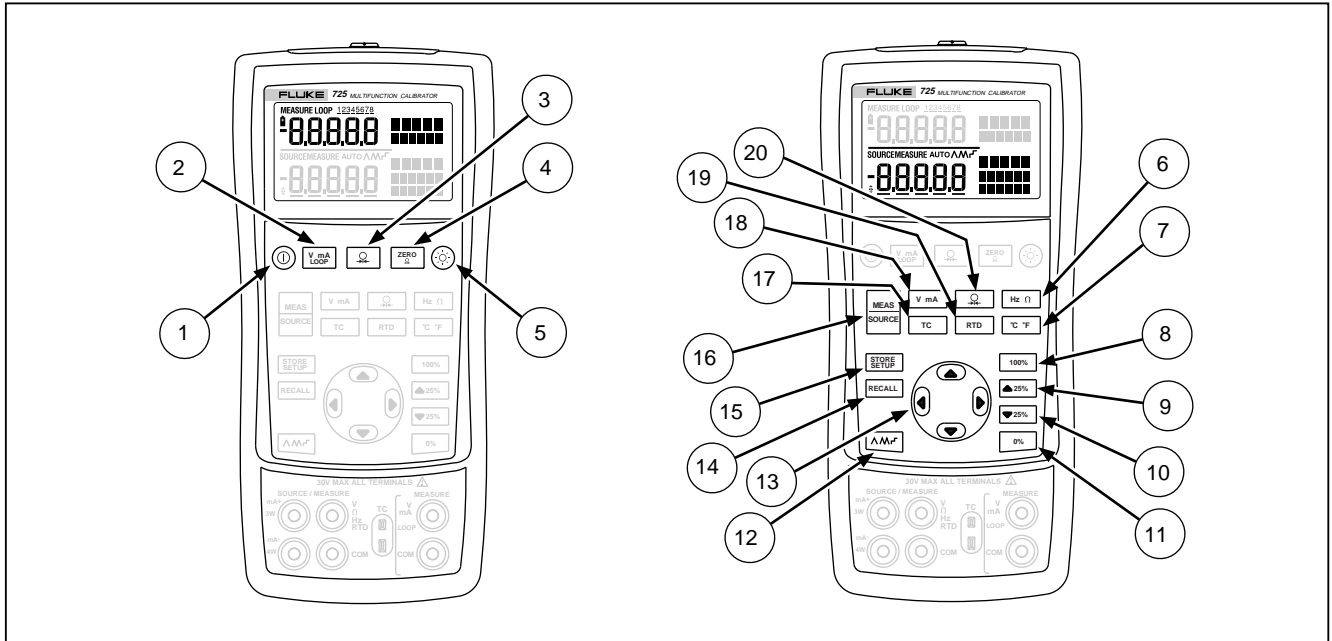

Figure 2. Keys

sh41f.eps

Table 3. Key Functions













| No | Name | Description |
|----|--|---|
| ① | Ⓢ | Turns the power on or off. |
| ② | V mA LOOP | Selects voltage, mA or Loop Power measurement function in the upper display. |
| ③ |  | Selects the pressure measurement function in the upper display. Repeated pushes cycle through the different pressure units. |
| ④ | ZERO  | Zeros the pressure module reading. This applies to both upper and lower displays. |
| ⑤ |  | Turns backlight on or off. |
| ⑥ | Hz Ω | Toggles frequency and ohms measurement and sourcing functions. |
| ⑦ | °C °F | Toggles between Centigrade or Fahrenheit when in TC or RTD functions. |
| ⑧ | 100% | Recalls from memory a source value corresponding to 100 % of span and sets it as the source value. Press and hold to store the source value as the 100 % value. |
| ⑨ | ▲ 25% | Increments output by 25 % of span. |
| ⑩ | ▼ 25% | Decrements output by 25 % of span. |
| ⑪ | 0% | Recalls from memory a source value corresponding to 0 % of span and sets it as the source value. Press and hold to store the source value as the 0 % value. |

Table 3 . Key Functions (cont.)

| No | Name | Description |
|----|---|--|
| ⑫ |  | Cycles through : ^ Slow repeating 0 % - 100 % - 0 % ramp M Fast repeating 0 % - 100 % - 0 % ramp □ Repeating 0 % - 100 % - 0 % ramp in 25 % steps |
| ⑬ |  | Increases or decreases the source level. Cycles through the 2-, 3-, and 4-wire selections. Moves through the memory locations of calibrator setups. |
| ⑭ |  | Retrieves a previous calibrator setup from a memory location. |
| ⑮ |  | Saves the calibrator setup. |
| ⑯ |  | Cycles the calibrator through MEASURE and SOURCE modes in the lower display. |
| ⑰ |  | Selects TC (thermocouple) measurement and sourcing function in the lower display. Repeated pushes cycle through the thermocouple types. |
| ⑱ |  | Toggles between voltage, mA sourcing, or mA simulate functions in the lower display. |
| ⑲ |  | Selects RTD (resistance temperature detector) measurement and sourcing function in lower display. Repeated pushes cycle through the RTD types. |
| ⑳ |  | Selects the pressure measurement and sourcing function. Repeated pushes cycle through the different pressure units. |

Display

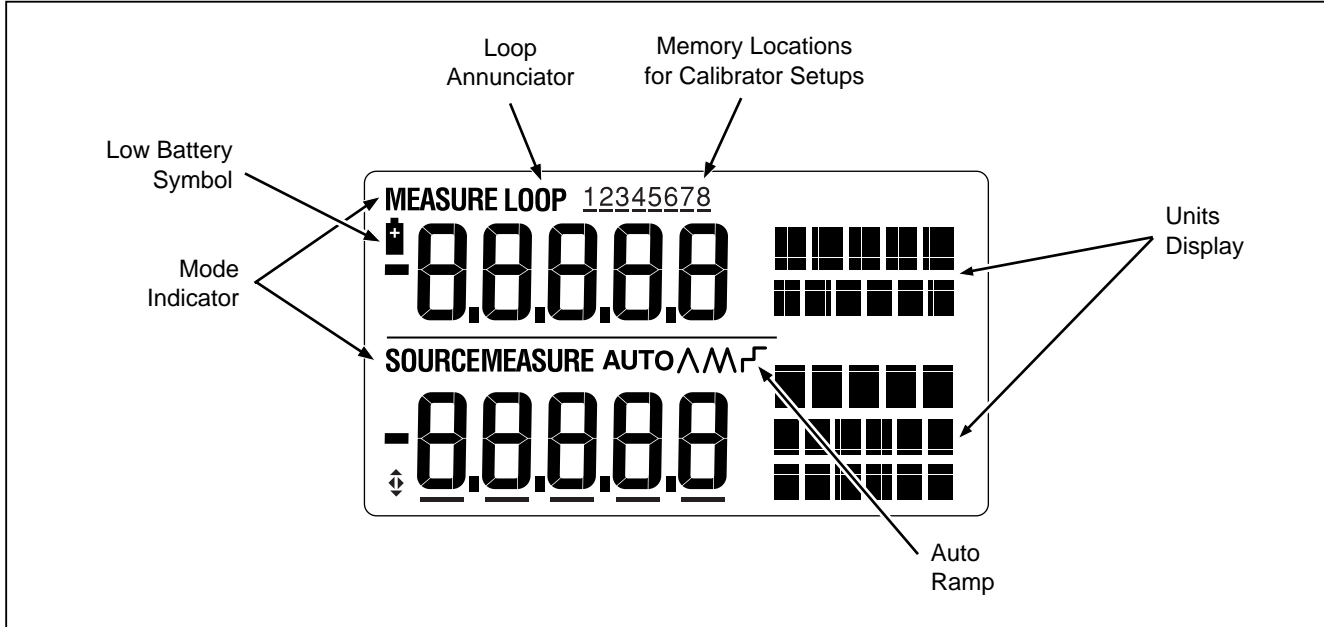

Figure 3. Elements of a Typical Display

sh07f.eps

Replacing the Batteries

⚠ Warning

To avoid false readings, which could lead to possible electric shock or personal injury, replace the batteries as soon as the battery indicator (🔋) appears.

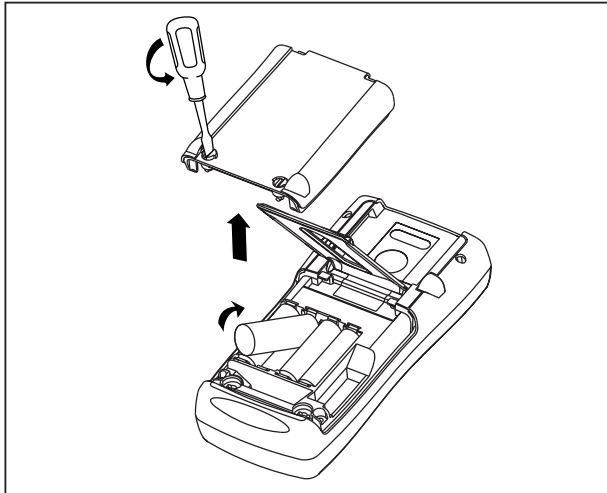

sh38f.eps

Figure 4. Replacing the Batteries

Replacement Parts

Table 4 lists the part number of each replaceable part. Refer to Figure 5.

Table 4. Replacement Parts

| Item | Description | PN | Qty. |
|------|--|------------------|--------|
| 1 | Case top | 664232 | 1 |
| 2 | LCD mask | 664273 | 1 |
| 3 | Elastomeric strips | 802063 | 2 |
| 4 | Input/output bracket | 691391 | 1 |
| 5 | LCD bracket | 658390 | 1 |
| 6 | Mounting screws | 494641 | 11 |
| 7 | Backlight | 690336 | 1 |
| 8 | LCD | 690963 | 1 |
| 9 | Keypad | 690955 | 1 |
| 10 | Case bottom | 664235 | 1 |
| 11 | AA alkaline batteries | 376756 | 4 |
| 12 | Case screws | 832246 | 4 |
| 13 | Battery door | 664250 | 1 |
| 14 | Accessory mount | 658424 | 1 |
| 15 | Tilt stand | 659026 | 1 |
| 16 | Battery door 1/4-turn fasteners | 948609 | 2 |
| 17 | TL75 series test leads | 855742 | 1 |
| 18 | Test lead, red Test lead, black | 688051 688066 | 1 1 |
| 19 | <i>725 Product Overview Manual</i> | 1549644 | 1 |
| 20 | AC70A alligator clip, red AC70A alligator clip, black | 738047 738120 | 1 1 |
| 21 | CD ROM, contains User Manual | 1549615 | 1 |
| 22 | Input Decal | 690948 | 1 |

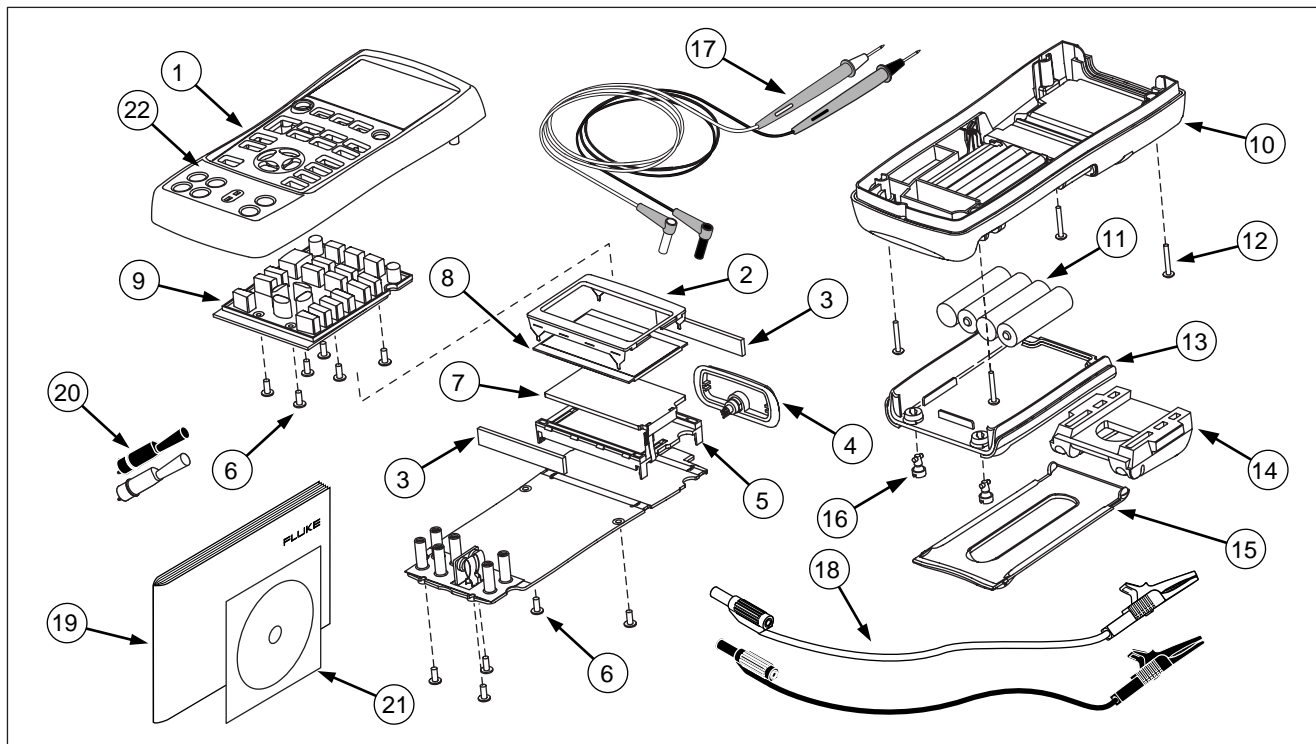

Figure 5. Replacement Parts

zi45f.eps

Specifications

All specifications apply from +18 °C to +28 °C unless stated otherwise. All specifications assume a 5 minute warmup period.

DC Voltage Measurement

| Range | Resolution | Accuracy, (% of Reading + Counts) |
|---|------------|--------------------------------------|
| 30 V (upper display) | 0.001 V | 0.02 % + 2 |
| 20 V (lower display) | 0.001 V | 0.02 % + 2 |
| 90 mV | 0.01 mV | 0.02 % + 2 |
| Temperature coefficient -10 °C to 18 °C, +28 °C to 55 °C: ±0.005 % of range per °C | | |

DC Voltage Source

| Range | Resolution | Accuracy, (% of Reading + Counts) |
|---|------------|--------------------------------------|
| 100 mV | 0.01 mV | 0.02 % + 2 |
| 10 V | 0.001 V | 0.02 % + 2 |
| Temperature coefficient -10 °C to 18 °C, +28 °C to 55 °C: ±0.005 % of range per °C | | |
| Maximum load: 1 mA | | |

DC mA Measurement and Source

| Range | Resolution | Accuracy, (% of Reading + Counts) |
|---|------------|--------------------------------------|
| 24 mA | 0.001 mA | 0.02 % + 2 |
| Temperature coefficient -10 °C to 18 °C, +28 °C to 55 °C: ±0.005 % of range per °C | | |
| Drive capability: 1000 Ω at 20 mA | | |

Millivolt Measurement and Source*

| Range | Resolution | Accuracy |
|--|------------|----------------------|
| -10 mV to 75 mV | 0.01 mV | ±(0.025 % + 1 count) |
| Maximum input voltage: 30 V | | |
| Temperature coefficient -10 °C to 18 °C, +28 °C to 55 °C: ±0.005 % of range per °C | | |
| *Select this function by pressing <input type="checkbox"/> TC. The signal is available at the thermocouple miniplug connector. | | |

Ohms Measurement

| Ohms Range | Accuracy $\pm \Omega^*$ | |
|--|-------------------------|---------------|
| | 4-Wire | 2- and 3-Wire |
| 0 to 400 Ω | 0.1 | 0.15 |
| 400 to 1.5 k Ω | 0.5 | 1.0 |
| 1.5 to 3.2 k Ω | 1 | 1.5 |
| Temperature coefficient -10 °C to 18 °C, +28 °C to 55 °C: ± 0.005 % of range per °C Excitation Current: 0.2 mA Maximum input voltage: 30 V * 2-wire: Does not include lead resistance. 3-wire: Assumes matched leads with a total resistance not exceeding 100 Ω . | | |

Ohms Source

| Ohms Range | Excitation Current from Measurement Device | Accuracy $\pm \Omega$ |
|---|--|-----------------------|
| 15 to 400 Ω | 0.15 to 0.5 mA | 0.15 |
| 15 to 400 Ω | 0.5 to 2 mA | 0.1 |
| 400 to 1.5 k Ω | 0.05 to 0.8 mA | 0.5 |
| 1.5 to 3.2 k Ω | 0.05 to 0.4 mA | 1 |
| Temperature coefficient -10 °C to 18 °C, +28 °C to 55 °C: ± 0.005 % of resistance range per °C | | |
| Resolution | | |
| 15 to 400 Ω | 0.1 Ω | |
| 400 to 3.2 k Ω | 1 Ω | |

Frequency Measurement

| Range | Resolution | Accuracy |
|---|------------|-----------------------------------|
| 2.0 to 1000.0 CPM | 0.1 CPM | $\pm (0.05 \% + 1 \text{ count})$ |
| 1 to 1100 | 0.1 Hz | $\pm (0.05 \% + 1 \text{ count})$ |
| 1.0 to 10.0 kHz | 0.01 kHz | $\pm (0.05 \% + 1 \text{ count})$ |
| Sensitivity: 1 V peak-to-peak minimum Waveform: squarewave | | |

Frequency Source

| Range | Resolution | Accuracy (% of output frequency) |
|--|------------|----------------------------------|
| 2.0 to 1000.0 CPM | 0.1 CPM | $\pm 0.05 \%$ |
| 1 to 1100 Hz | 1 Hz | $\pm 0.05 \%$ |
| 1.0 to 10.0 kHz | 0.1 kHz | $\pm 0.25 \%$ |
| Waveform: 5 V p-p squarewave, -0.1 V offset | | |

Temperature, Thermocouples

| Type | Range | Measure and Source Accuracies |
|----------------------|--|-------------------------------|
| J | -200 to 0 °C 0 to 1200 °C | 1.0 °C 0.7 °C |
| K | -200 to 0 °C 0 to 1370 °C | 1.2 °C 0.8 °C |
| T | -200 to 0 °C 0 to 400 °C | 1.2 °C 0.8 °C |
| E | -200 to 0 °C 0 to 950 °C | 0.9 °C 0.7 °C |
| R | -20 to 0 °C 0 to 500 °C 500 to 1750 °C | 2.5 °C 1.8 °C 1.4 °C |
| S | -20 to 0 °C 0 to 500 °C 500 to 1750 °C | 2.5 °C 1.8 °C 1.5 °C |
| B | 600 to 800 °C 800 to 1000 °C 1000 to 1800 °C | 2.2 °C 1.8 °C 1.4 °C |
| L | -200 to 0 °C 0 to 900 °C | 0.85 °C 0.7 °C |
| U | -200 to 0 °C 0 to 400 °C | 1.1 °C 0.75 °C |
| N | -200 to 0 °C 0 to 1300 °C | 1.5 °C 0.9 °C |
| Resolution: | | |
| J, K, T, E, L, N, U: | | 0.1 °C, 0.1 °F |
| B, R, S: | | 1 °C, 1 °F |

Loop Power Supply

Voltage: 24 V

Maximum current: 22 mA

Short circuit protected

RTD Excitation (simulation)

| Allowable Excitation by RTD type | |
|----------------------------------|-----------------|
| Ni 120 | 0.15 to 3.0 mA |
| Pt 100-385 | 0.15 to 3.0 mA |
| Pt 100-392 | 0.15 to 3.0 mA |
| Pt 100-JIS | 0.15 to 3.0 mA |
| Pt 200-385 | 0.15 to 3.0 mA |
| Pt 500-385 | 0.05 to 0.80 mA |
| Pt 1000-385 | 0.05 to 0.40 mA |

Pressure Measurement

| Range | Resolution | Accuracy | Units |
|-------------------------------|------------|-------------------------------|---|
| Determined by pressure module | 5 digits | Determined by pressure module | psi, inH ₂ O@4 °C, inH ₂ O@20 °C, kPa, cmH ₂ O@4 °C, cmH ₂ O@20 °C, bar, mbar, kg/cm ² , mmHg, inHg |

Temperature, RTD Ranges, and Accuracies

| Type | Range °C | Accuracy | | |
|------------|--------------|-------------------|---------------------------|-----------|
| | | Measure 4-Wire °C | Measure 2- and 3-Wire* °C | Source °C |
| Ni120 | -80 to 260 | 0.2 | 0.3 | 0.2 |
| Pt100-385 | - 200 to 800 | 0.33 | 0.5 | 0.33 |
| Pt100-392 | -200 to 630 | 0.3 | 0.5 | 0.3 |
| Pt100-JIS | -200 to 630 | 0.3 | 0.5 | 0.3 |
| Pt200-385 | -200 to 250 | 0.2 | 0.3 | 0.2 |
| | 250 to 630 | 0.8 | 1.6 | 0.8 |
| Pt500-385 | -200 to 500 | 0.3 | 0.6 | 0.3 |
| | 500 to 630 | 0.4 | 0.9 | 0.4 |
| Pt1000-385 | -200 to 100 | 0.2 | 0.4 | 0.2 |
| | 100 to 630 | 0.2 | 0.5 | 0.2 |

Resolution: 0.1 °C, 0.1 °F
Allowable excitation current (source): Ni120, Pt100-385, Pt100-392, Pt100-JIS, Pt200-385: 0.15 to 3.0 mA
Pt500-385: 0.05 to 0.80 mA; Pt1000-385: 0.05 to 0.40 mA
RTD Source: Addresses pulsed transmitters and PLCs with pulses as short as 5 ms.
* 2-wire: Does not include lead resistance.
3-wire: Assumes matched leads with a total resistance not exceeding 100 Ω.

General Specifications

| | |
|---|--|
| Operating temperature | -10 °C to 55 °C |
| Storage temperature | - 20 °C to 71 °C |
| Operating altitude | 3000 meters above mean sea level |
| Relative Humidity (% RH operating without condensation) | 90 % (10 to 30 °C) 75 % (30 to 40 °C) 45 % (40 to 50 °C) 35 % (50 to 55 °C) uncontrolled < 10 °C |
| Vibration | Random, 2 g, 5 to 500 Hz |
| Safety | EN 61010-1:1993, ANSI/ISA S82.01-1994; CAN/CSA C22.2 No 1010.1:1992 |
| Power requirements | 4 AA alkaline batteries |
| Size | 96 x 200 x 47 mm. (3.75 x 7.9 x 1.86 in) |
| Weight | 650 gm (1 lb, 7 oz) |